



Shock Absorber Rebuild Manual

Model

FLOAT X EVOL



FOX RACING SHOX

130 Hangar Way, Watsonville, CA 95076

PHONE 800.369.7469 ext. 7647

FAX 831.768.7026

Email: info@foxracingshox.com

Website: www.foxracingshox.com

TABLE OF CONTENTS

Disclaimer.....	3
Consumer Safety.....	3
Removal & Installation.....	3
Recommended Service Intervals.....	3
Service Tools / Consumables.....	4
Fox Special Tools.....	4
Fox FLOAT X EVOL Service Parts Kit.....	5
Rebuild Instructions.....	6 - 20
Contact Information.....	21
Service.....	21
Warranty Policy.....	21
Methods of Payment.....	21
Methods of Shipping.....	21



Disclaimer

FOX Racing Shox is not responsible for any damages to you or others arising from riding, transporting, or other use of your FOX-equipped vehicle. In the event that your shock breaks or malfunctions, FOX Racing Shox shall have no liability or obligation beyond the repair or replacement of your shock, pursuant to the terms outlined in the Service and Warranty provisions of this manual.

Consumer Safety

RIDING A MOTOR VEHICLE IS DANGEROUS AND CAN RESULT IN SERIOUS INJURY OR DEATH. RIDE RESPONSIBLY AT ALL TIMES.

- Maintain your vehicle and your suspension.
- Always wear a helmet, protective clothing and eye protection.
- Ride within your limits.
- Tread lightly.

Removal & Installation

The method for removing and installing your FOX Racing Shox is different for every vehicle. Refer to your vehicle's service manual for complete instructions.

Recommended Service Intervals

Your FOX Racing Shox will perform the best if serviced at regular intervals:

Every Ride	Wash and dry your vehicle and suspension.
Every 100 hours	Visually inspect shock seals.
Every 500 hours or Annually	Change shock oil and seals.

Service Tools / consumables

Safety Glasses
Latex Gloves
Vice w/soft-grip jaws
Clean, lint-free workshop cloth
Air compressor w/ snub nose adaptor
Regulated Nitrogen pre-charge rig with Schrader adaptor
Pin spanner / wrench
Torque wrench
Assorted sockets
Glass beaker (or suitable container) for used oil
Light viscosity Lithium-based grease (assembly lube)
Scribe / Dental Pick tool
5/64" Hex key (Allen wrench)
T15 Torx wrench
Small magnet
Rubber Mallet
Air sleeve rubber strap wrench

FOX Special Tools

Service Rebuild Kit	FOX P/N 803-00-229
Bearing Head removal/install tool (Torque wrench extension)	FOX P/N 398-00-249
Air sleeve bullet tool	FOX P/N 398-00-244
Shaft bullet tool	FOX P/N 398-00-026-B
Reservoir end cap extraction tool / IFP setting tool	FOX P/N 803-00-294
Bearing Holder / O-Ring Install Tool	FOX P/N 398-00-279
Continuous Piston Band Installation Tool	FOX P/N 803-00-288
Shaft and Body Clamp (Ø1.459 Bore, 0.50" Shaft)	FOX P/N 398-00-283
DSC Valve 29mm Hex Install Tool	FOX P/N 398-00-267
FOX Oil High VI Race Oil (light - 5wt, 1.0 Quart)	FOX P/N 803-11-005
FOX Oil High VI Race Oil (light - 5wt, 1.0 Gallon)	FOX P/N 803-11-004

**FOX FLOAT X EVOL Service Parts Kit (1 pair of shocks) 803-00-229**

<u>Description</u>	<u>Qty</u>	<u>Part Number</u>
BODY CAP O-RING	2	Fox P/N 029-01-135-A
EXTERNAL O-RING	2	Fox P/N 029-03-033-A
SAMURAI WIPER (Blue)	2	Fox P/N 036-02-016-A
SAMURAI BACK-UP SEAL (Black)	2	Fox P/N 036-02-017-A
AIR SLEEVE SEAL	2	Fox P/N 036-01-014-A
AIR SLEEVE SLYD RING	4	Fox P/N 002-00-013
CONTINUOUS PISTON BAND	2	Fox P/N 002-02-015
PISTON O-RING	2	Fox P/N 029-08-066
SHAFT SEAL	2	Fox P/N 036-01-013-A
SHAFT O-RING	2	Fox P/N 029-06-112-A
BEARING TO BODY O-RING	2	Fox P/N 029-03-125-A
IFP O-RING	2	Fox P/N 029-00-324-A
IFP BEARING	2	Fox P/N 002-00-000-A
EVOL IFP O-RING	2	Fox P/N 029-00-211-A
CD HOUSING O-RING (INNER)	2	Fox P/N 029-02-019-A
CD HOUSING (OUTER) / END CAP O-RING	4	Fox P/N 029-03-022-A
FOX Float Fluid (5cc pillow pack)	2	Fox P/N 025-03-002-A

Correct o-ring placement is CRITICAL to ensure correct shock performance and to avoid leaks. When replacing an o-ring, check the “old” o-ring internal diameter and cross sectional diameter to ensure that you have the correct “new” o-ring out of the kit to replace it.

This following instruction will explain the differences between the Generation I vs. Generation II Shaft and Metering Rod design. There is a chance that if you are servicing an older set of Float X Evol shocks that it could contain Generation I parts that needs to be replaced.

Generation I parts are no longer available and has been completely replaced by Generation II parts.

If you service shocks with Generation I Shaft/Rod design, we recommend getting the parts replaced by Generation II Shaft/Rod.

Keep in mind to always replace these parts if the shocks come as a pair. Generation I and II parts are NOT interchangeable and WILL NOT work together.

1. To determine if the Rod/Shaft is of Generation I or II, disassemble the shock and inspect the parts per below, always update to Generation II parts.
2. Generation I Metering Rod vs. Generation II Metering Rod shown below. Always replace Shaft and Rod at the same time (Generation II has an o-ring gland).

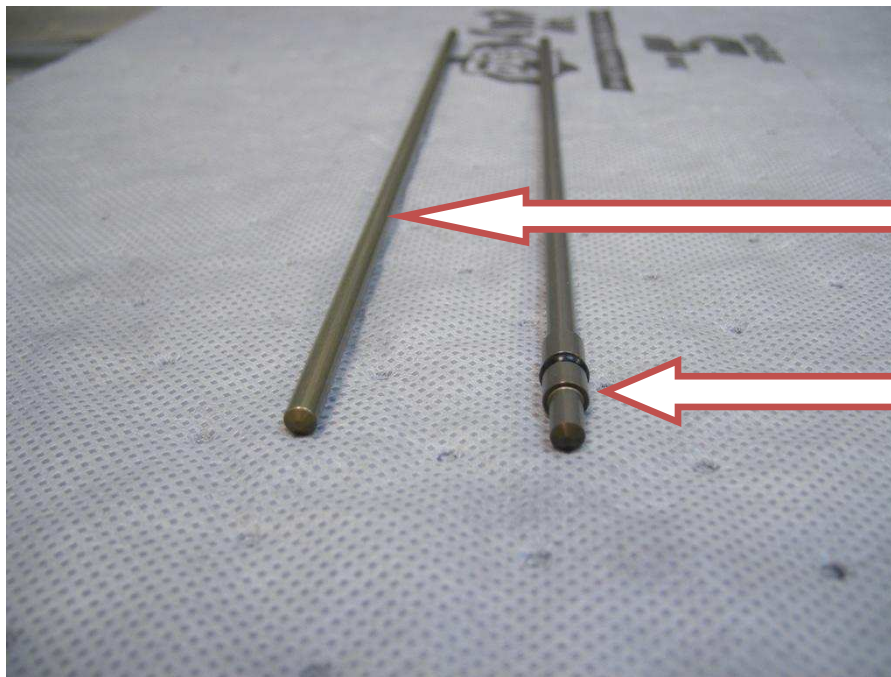

Generation I Metering Rod. (To be replaced.)

Generation II Metering Rod.

3. Generation I Shaft vs. Generation II Shaft shown below. It is critical to always replace the Shaft and Metering Rod at the same time.

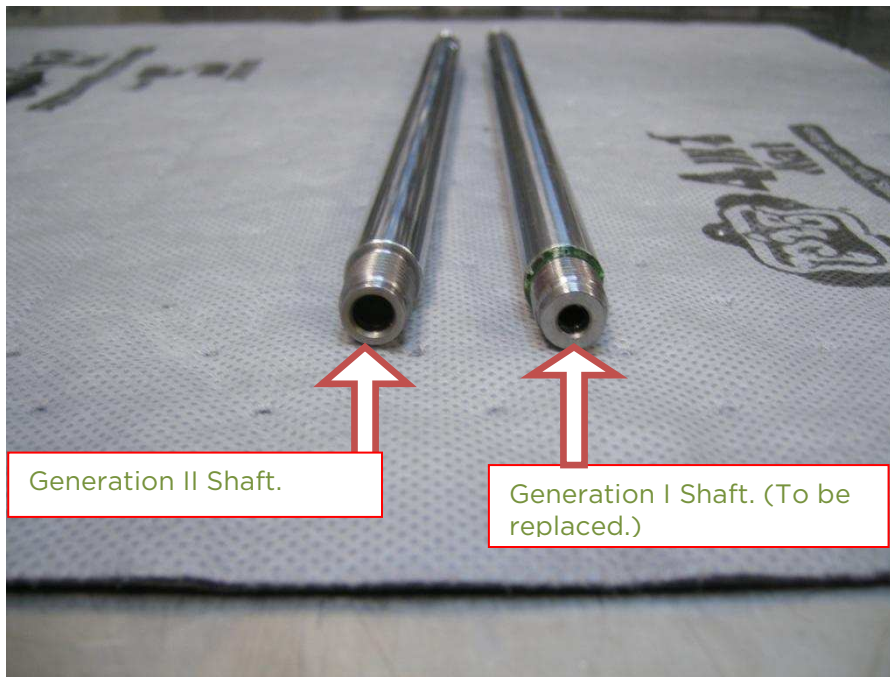

4. Generation II Metering Rod Part number series are 210-58-XXX
5. Generation II Shaft part number series are 229-49-XXX.

REBUILD INSTRUCTIONS

Important notes:

- SAFETY FIRST - Always wear safety glasses and read directions completely BEFORE disassembling the shock.
 - Cleanliness is critical, make sure your work area is clean and un-cluttered prior to starting work. Contamination of the shock will lead to premature wear and poor function of your shocks.
 - **IMPORTANT:** When replacing a seal during a service, make sure that the new seal is the same size, shape, and material as the one you are replacing. In some cases, there may be two seals in the rebuild kit that look
1. With your vehicle safely placed on a stand, carefully remove the shocks. Set the mounting hardware aside.
 2. Remove the eyelet reducers and o-rings, clean and set aside - keeping careful note of top and bottom reducers.
 3. Carefully wash and wipe the exterior of the shock to remove any dirt that may cause contamination.
 4. Check the position of the compression and rebound clickers. Do this by turning the knobs full clockwise and counting clicks. Rebound and compression clicker settings are counted as “clicks out” from full in clockwise (closed). The compression clicker should have between 18 and 20 clicks. The rebound clicker should have between 18 and 23 clicks. After you’ve checked the setting and for smooth operation of the clickers, back both adjusters fully out or full open (counter clock-wise).
 5. Securely mount the shock in a soft-jaw vice by the EVOL chamber end (BOTTOM).
 6. Remove the gold Schrader valve caps - set aside.
 7. Using the 150PSI FOX high pressure pump, take note of the main chamber pressure - Write it down. Using the 300PSI FOX high pressure pump, take note of the EVOL chamber pressure - Write it down. Using the pump, or a suitable blunt tool, depressurize the MAIN chamber (first) and the EVOL chamber (second). Both should hiss as air is released and the shock should contract slightly due to the internal negative spring.



8. Loosen the AIR SLEEVE [38] -, use a strap-wrench positioned over the very end of the sleeve to prevent distortion. Un-tighten, but do not fully remove the air-sleeve yet.
9. Flip the orientation of the shock and securely fasten it in the vice by reservoir end (TOP).
10. Completely un-thread the air sleeve from the EVOL body cap by hand and slide it down the body. Look for oil in the air chamber, sitting on top of the bearing head assembly. This indicates worn shaft seals. There should be a small amount of assembly lube present but no shock oil in the air chamber.



11. Using a pin spanner wrench, remove the RESERVOIR SCHRAEDER CAP [49] - set aside.



12. Using a suitable sharp-pointed object, depressurize the nitrogen charge completely by pressing the center pin of the Schrader.
13. Push the RESERVOIR END CAP [51] down and use a pick-tool to remove the RESERVOIR SNAP RING [52]. Pull the reservoir end cap out of the reservoir (Use FOX Reservoir End Cap Extraction tool). With End cap removed, measure the depth of the IFP in the reservoir for reference during reassembly.

*Note your IFP Depth _____

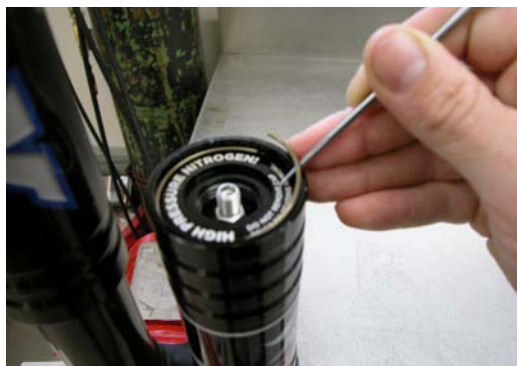

14. Using a 5/64" Allen wrench, carefully loosen the BLEED SET SCREW [41] and remove the BALL BEARING [29] - set aside (tip: use a small magnet to remove the ball from the hole).

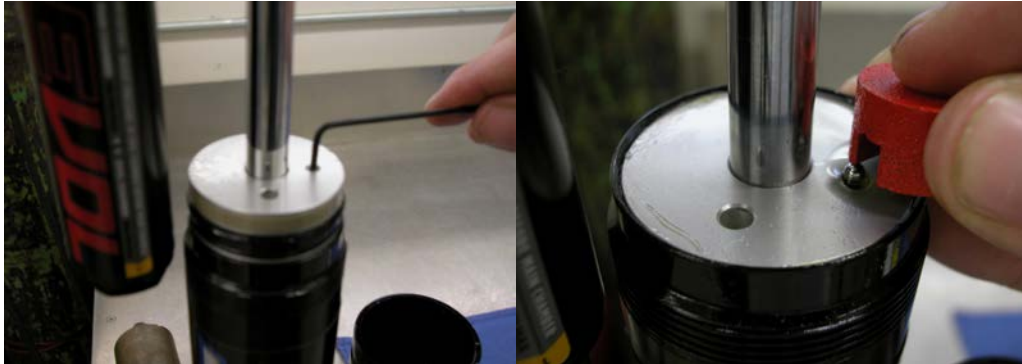

15. Using IFP setting tool, raise the IFP approximately 1" such that the oil height in the shock body is lowered.
16. Using the FOX bearing head removal tool, unscrew the BEARING HEAD ASSEMBLY [42] from the shock.



17. Grasp the EVOL chamber end (BOTTOM) of the shock, gently pull the piston / shaft / bearing / EVOL end of the shock free from the reservoir half of the shock. You may need to gently wiggle/rock the shaft to help.



18. Set the EVOL chamber (BOTTOM) half of the shock on a clean, dry piece of lint-free cloth.

19. Remove the air-sleeve from the reservoir end of the shock. During normal operation, the exterior of the air sleeve may get minor chips in the anodizing from roost. If the shock has sustained significant damage from large rocks or flying debris the air sleeve will need to be replaced.



20. Inspect the air sleeve EXTERNAL O-RING [35], replace if necessary.
21. Examine the condition of the AIR SLEEVE BEARING [14], SAMURAI BACK-UP SEAL [13] and SAMURAI WIPER [12]. If the two seals show signs of wear these components should be replaced, as outlined in the following steps. If the air sleeve bearing is badly worn or scored, you will need a new air sleeve or the sleeve will need to be returned to Fox Racing Shox for the bearing to be replaced.
22. Carefully use a pick tool to remove the samurai seal and back-up seal from the air sleeve. Take care not to score any of the aluminum seal seating surfaces.



23. Take the bottom end of the shock out of the vice and tip the oil into a clean glass beaker (or suitable clean container) to examine the condition of the shock oil. There should be no large wear particles in the oil. Very old oil may show signs of break-down and be darker in color. The oil should not be emulsified (creamy) or aerated. Remove the Internal Floating Piston I.F.P [59] from the reservoir to ensure that all the oil is completely discharged from the shock. Set the damper body aside.



24. Make sure to dispose of used shock oil correctly. Do NOT re-use old shock oil, this may lead to contamination and premature wear.
25. Clamp the EVOL chamber (BOTTOM) end of the shock in a soft-jaw vice.
26. Examine the CONTINUOUS PISTON BAND [7] for signs of wear, replace if necessary - as outlined below.
27. Undo the SHAFT NUT [5] and remove the PISTON [6] and valving assembly. Set on a clean, dry lint-free cloth. If making a valving change, adjust the shims as required.



28. Remove the BEARING HEAD ASSEMBLY [42] from the shaft, taking care to note the order of the NEGATIVE SPRING [9], THRUST WASHER [9a], SPACER [10] etc. Set these pieces aside.
29. Inspect the BODY CAP O-RING [34]. Replace this part if necessary, making sure to install the new o-ring in the o-ring gland and not in the thread relief.
30. Inspect the condition of the internal SHAFT SEAL [46] and SHAFT O-RING [47] in the bearing head assembly. If they are worn, or if there were signs of oil present in the air-sleeve, replace these parts (as outlined below).
31. Inspect the SHAFT BEARING [48], if it is worn, return the bearing head assembly to FOX for replacement.
32. Clamp the Bearing Holder / O-Ring Install Tool into the vice and place the SHAFT BEARING [48] onto the tool.



33. Check the condition of AIR SLEEVE SEAL [44] and AIR SLEEVE SLYDE RINGS [43]. These components should be replaced if they show signs of wear. There should be no signs of damage or wear to the aluminum bearing head. If the air seal needs to be replaced, use a pick tool to remove the old seal from the shaft. Use extreme caution when using a scribe to remove seals. Always “spear” the seal with the point of the scribe. Do not wedge the point of the scribe in behind the seal. This can scratch the surface of the seal groove, which will compromise the performance and reliability of the shock absorber.
34. Pointing the scribe downward, spear the air piston seal in the center groove and pry it outward away from the bearing assembly. Insert the barrel of a pen (or similar plastic part that will not scratch the aluminum) behind the air piston seal and pry it all the way out of its groove and off of the bearing assembly.



35. Using a little assembly lube, carefully work the replacement seal into the seal groove of the bearing. **The grooved side of the seal (concave) should point towards the non threaded end of the bearing. The orientation of this seal is critical. Be sure it is oriented correctly!**



36. Using a pick tool, while taking care not to score the aluminum, remove the SHAFT SEAL [46] and SHAFT O-RING [47]. Again, using a little assembly lube, carefully work the replacement o-ring and seal into the bearing. You may need to use a small, blunt tool to help work these parts into place.



37. Inspect the BEARING TO BODY O-RING [45], if it is in poor condition, replace.



38. If you would like to inspect the condition of the EVOL IFP [21] and EVOL IFP O-Ring [22], apply a loosening torque to the EVOL RESERVOIR END CAP [17] and to the EVOL RESERVOIR [20] using a 1" wrench and a rubber strap wrench respectively. In this manner, remove the end cap and reservoir from the EVOL OFFSET ADAPTOR [23] as a single unit. To bypass the EVOL chamber overhaul, skip to step 43.



39. To remove the EVOL IFP [21] from the EVOL RESERVOIR [20], cover the end of the reservoir with a rag and charge the SCHRADER VALVE [16] with a jet of compressed air to shoot the IFP out of the chamber.



40. Inspect the condition of the IFP and o-ring and replace if necessary.
41. Run a grease-covered finger around the inside of the EVOL reservoir to lubricate the surface, taking care NOT to introduce large amounts of grease to the EVOL reservoir.
42. Add 1-2cc's of float fluid to the Evol reservoir by dribbling it down the inside wall of the EVOL chamber. This helps to lubricate the IFP and is the only lubrication this part receives during normal operation.
43. Make sure the EVOL IFP and o-ring are heavily lubricated with grease prior to re-assembly. Re-install the IFP.
44. Inspect the EVOL RESERVOIR O-RING [18] for damage or wear, replace.
45. Torque the EVOL RESERVOIR END CAP [17] to 12FT-LBS.
46. Place the bullet tool on the shaft.



47. Lubricate the bearing with some assembly grease - install on the shaft. Install the negative spring spacer, negative spring, and damping piston/valving assemblies.

48. Torque the piston nut to 18ft.lbs. Remove the piston assembly from the vice and set on a clean, lint free rag.



49. Take the FOX air sleeve and cover the new samurai backup seal with a little assembly lube, work the seal into the groove, ensuring the orientation of the seal is correct. The seal lip should face outwards. Install black seal 1st and blue seal 2nd.

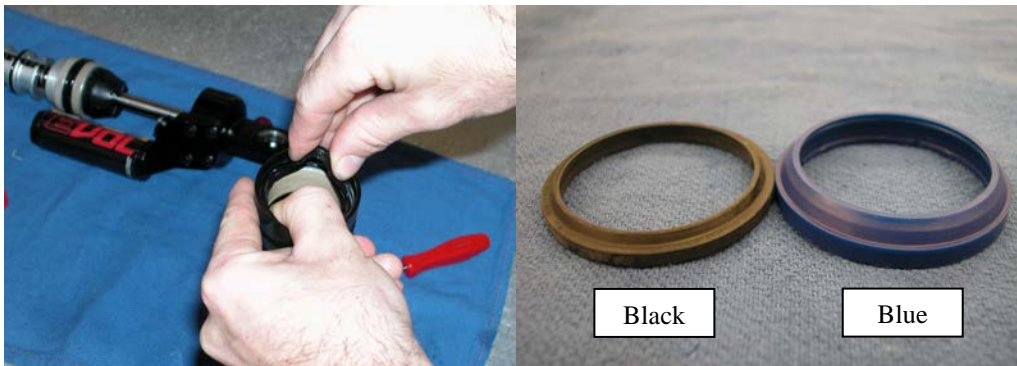

50. Using a small amount of assembly lube, install the new samurai wiper, ensuring the seal lip is orientated outwards.



51. Heavily lubricate the seal and bearing surfaces of the FLOAT X EVOL air sleeve. Completely fill the seal and bearing glands with assembly lube.



52. Use the air sleeve bullet tool and lube to slide the air sleeve back onto the body.



53. Set the slow speed DSC adjuster to fully open.
54. Fill the piggyback reservoir with clean oil almost to the rim - it is normal for oil to seep through the CD into the shock body, just keep topping-off the reservoir until close to over-flowing.
55. Set the slow speed DSC adjuster to fully closed, remove the IFP bleed screw and insert the IFP into the reservoir.
56. Slowly push the IFP down into the oil, ensuring that the trapped air bleeds out of the hole. DO NOT push the IFP to the bottom of the reservoir yet.
57. Install the IFP bleed screw. It is ok to leave some oil trapped in the reservoir, above the piston.
58. To bleed the DSC mechanism, open the slow speed DSC adjuster and push the IFP to the bottom of the reservoir. Next, pull the IFP back to 2" from the top of the reservoir. Repeat this step several times to ensure a full bleed.

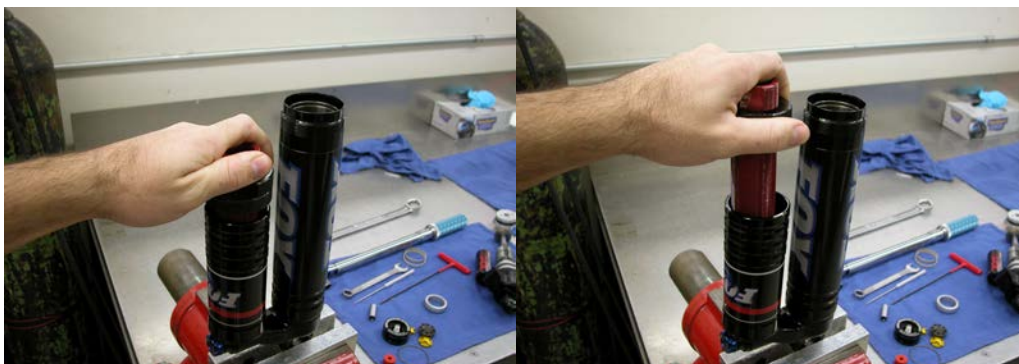

59. Fill the shock body with oil to about 1.5" from the top of the shock body and close the slow speed DSC adjuster.



60. Back out the rebound adjuster on the shaft assembly. Using a small Allen wrench, depress the METERING ROD [39] by inserting the long end of the Allen wrench into the SHAFT POST [4] and lightly pressing until the metering rod moves away from the jet.

61. While holding the negative spring and spacer at the top of the shaft with one hand, insert the shaft and bearing assembly into the shock lower, taking care not to spill oil into the air-sleeve.



62. Very slowly push the shaft down into the oil, while rotating and wiggling the shaft until there are no bubbles rising in the oil.

63. Using a rubber mallet, gently tap the shaft to allow air trapped between the piston and valve shims to escape.



64. Gently lower the negative spring and spacer into the oil, taking care not to let the oil overflow into the air sleeve.

65. Make sure the piston assembly and the rebound hole in the shaft DO NOT come out of the oil bath. If the rebound adjust hole in the shaft comes out of the oil bath, air can transfer to the underside of the piston, aerating the shock. Add oil to the shock as required to keep the hole covered. Pull the shaft assembly out of the oil until the top of the negative spring is even with the end of the body.
66. Add 1-2cc's of Float fluid to the gap between the air sleeve and the damper body (underneath the bearing). The Float fluid lubricates the external sliding air sleeve seals. Do this before installing the bearing head assembly. This Float fluid lubricates the back-side of the Float air seal and is the only lubrication (other than the assembly lube) that the seal has during normal operation.



67. Fit the 2 AIR-SLEEVE SLIDE RINGS [43] onto the bearing head, on either side of the air-seal.

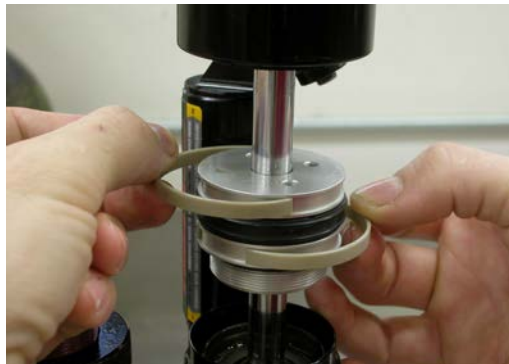

68. Heavily lubricate the seal and slide rings. Make sure the glands are filled with assembly lube.
69. Carefully lower the bearing assembly onto the damping body and thread into the shock. Use the FOX Bearing head tool to torque the bearing assembly to 50FT-LBS. Some shocks may require the air sleeve to be slid partially onto the bearing prior to threading the bearing into the body (depending on length).

50 ft-lbs



70. Pull the shaft to make sure the shock is extended to the point where the negative spring just contacts the bearing.
71. Pull the air sleeve up onto the bearing, to stop excess oil from running into the underside of the bearing.



72. Using the FOX reservoir end cap and IFP tool, slowly push the IFP down to the correct setting per the diagram below. This forces fluid through the shock and out of the hole in the bearing. You should see fluid flowing out into the air sleeve and bubbles of air. As you get close to the correct IFP setting there should be no more bubbles of air coming out of the bleed hole.

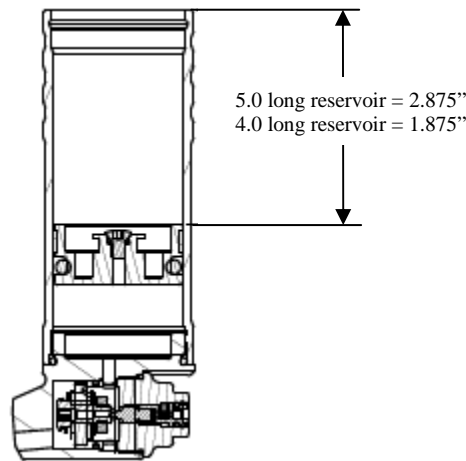

73. Drop the ball bearing into the hole and install the bleed set screw to seal the shock- lightly torque to 48 in-lbs.



74. Tip out excess fluid out and mop up the top of the bearing with a rag. This portion of the shock should not have any oil present as it may block the air transfer port to the EVOL chamber. Oil in this part of the shock is also a useful indication of shaft seal wear. The shock should be dried thoroughly so as to not block the EVOL transfer port and to enable the next shock service technician to accurately diagnose correct shock seal performance.



74. Clean the excess fluid out of the reservoir from above the IFP.

75. Install the reservoir end cap and reservoir snap ring.



76. Charge the reservoir with Nitrogen to 225PSI. The shock should extend due to the compression of the negative spring.



77. Refit the reservoir SCHRADER CAP [49] and torque to 35IN-LBS.

78. Lightly run a finger around the air sleeve o-ring in the EVOL cap to ensure it is correctly seated in the gland with a little lube. Slide the air sleeve up the body and thread into the cap. Tighten using a strap wrench to ensure the sleeve is tight.



79. Use the 300PSI Fox High pressure pump to set the correct pressure in the EVOL chamber.



80. Use the 150PSI Fox High pressure pump to set the pressure in the MAIN chamber. It is normal for the shock to extend slightly.





81. Set the low speed compression (LSC), high speed compression (HSC) and rebound clicker positions. Turn the adjuster clockwise until it stops, this is the fully closed/firm position. Now, turn the adjuster counter clockwise while counting the number of clicks until the desired setting is reached. If the previous settings are not known use the following table as a starting point.

Weight	LSC	HSC	Rebound
140 lb	14 clicks out	14 clicks out	14 clicks out
180 lb	12 clicks out	12 clicks out	12 clicks out
200 lb	10 clicks out	10 clicks out	10 clicks out

82. Time permitting, we recommend allowing the shock to sit for 24 hours. This hold period allows you to re-inspect the shock and identify any possible oil, air or nitrogen leaks.
83. Congratulations, you have completed the servicing of your FOX Racing Shox! Re-fit the eyelet reducers and new o-rings and re-fit the shocks to the vehicle, using the manufacturers recommended torque settings.
84. After conducting a complete suspension tear-down, be sure to RIDE SLOWLY in the beginning to make sure the shock and your vehicle suspension are performing correctly.



Contact Information

FOX Racing Shox 130 Hangar Way Watsonville, CA 95076	Phone: 800.369.7469 ext. 7647 North America: 800.369.7469 Fax: 831.768.7026
E-mail: info@foxracingshox.com	Website: www.foxracingshox.com
Business Hours: Monday-Friday 8:00AM-5:00PM, Pacific Time	

Service / Warranty

1. Contact FOX Racing Shox at 800.FOX-SHOX (800-369-7469) to obtain a Return Authorization Number (RAN) and shipping instructions.
2. Satisfactory proof of purchase receipt is required for warranty consideration.
3. Mark the Return Authorization Number (RAN) and the Return Address on the outside of the box. Send the shock to FOX Racing Shox with the shipping pre-paid by sender.
4. Include a description of the problem, vehicle information (manufacture, year & model), type of FOX product, spring rate, type of riding, and a return address with daytime phone number.

Warranty Policy:

FOX Racing Shox products are covered by a 1-Year Limited Warranty against defects in materials and/or workmanship. Any modifications to the product will void all warranty. This Warranty will be extended to the original retail consumer of an OEM Customer's FOX Racing Shox equipped vehicle and is valid for one year from the original date of purchase from an OEM Customer's authorized dealer. Warranty is limited to the repair or replacement of the FOX Racing Shox product. FOX Racing Shox reserves the right of final decision with regards to all warranty related issues.

Warranty is void when damage to the shock has occurred from the following:

- Abuse.
- Seal damage due to power washing.
- Damage to the exterior finish caused by debris, rocks, or crashes.
- Any attempts to disassemble shock absorber.
- Modifications.
- Non-factory oil use or improper service
- Shipping damage or loss (purchase of full insurance is recommended).

Methods of Payment

VISA, MasterCard and/or Cashier's Check

Methods of Shipping

FOX Racing Shox uses UPS Ground Service within the USA. Customer may request UPS Air Service at an extra cost. All non-warranty shipping charges are the customer's responsibility.